

Pos. 01 Gehäuse

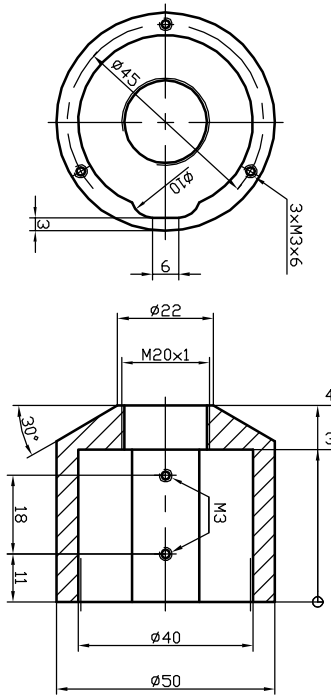

Pos. 02 Spindelgehäuse

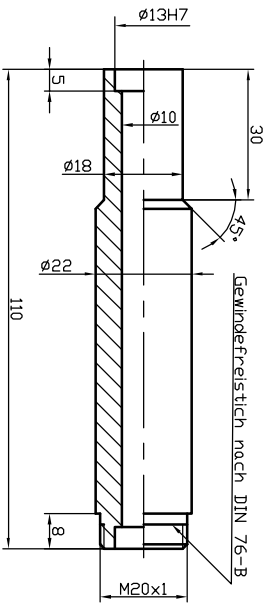

Pos. 04 Boden

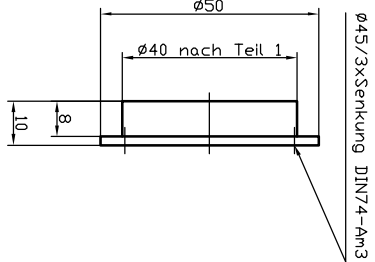

Pos. 05 Rotorkopf

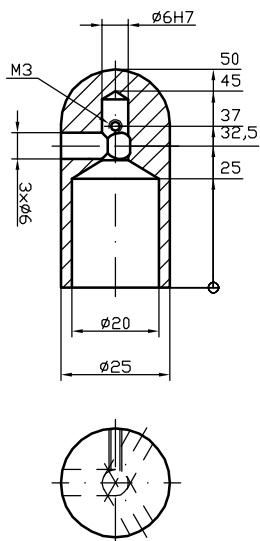

Pos. 07 Flügel

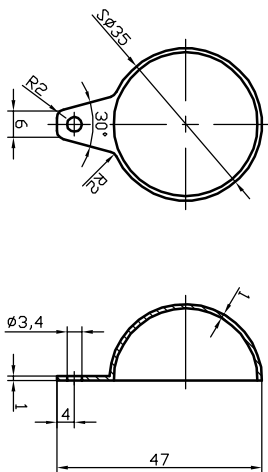

Pos. 06 Flügelarm

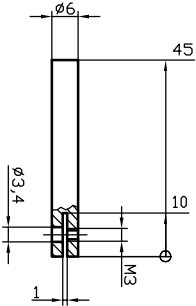

Pos. 12 Fächerscheibe

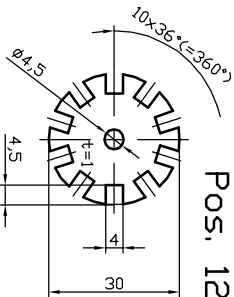

Pos. 03 Rotorspindel

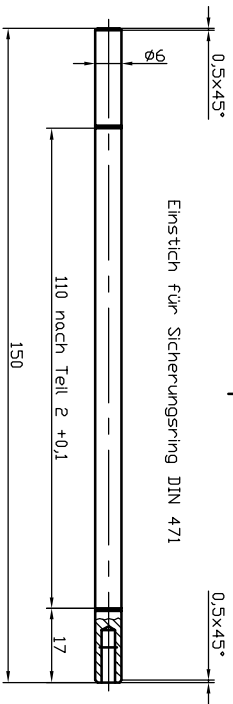

(Verwendungsbereich)		(Zul. Abw.)	(Oberfl.)	Maßstab 1:1	(Gewicht)
				(Werkstoff, Halbzeug) (Rohteil-Nr) (Modell- oder Gesenk-Nr)	
Zust.	Änderung	Datum	Name	Windmesser Einzelteile	
				002	
Ersatz für:				Ersatz durch:	
				Blatt	
				Blätter	